

# Pfaff 1442 Subclass

---

**PFAFF**<sup>®</sup> **1442**

**Unterklassen-Ausstattung**  
Subclass parts  
Composition des sous-classes  
Composición de las subclases

Unterklasse Subclass Subclasse	Ausführung Model Version Tipo de máquina	Nadelabstand in mm Needle gauge in mm Ecartement des aiguilles en mm Distancia entre agujas en mm	Nadelhalter <sup>1072</sup> Needle holder Pince-aiguille Portaagujas	Stoffschieber <sup>4</sup> <sup>101</sup> <sup>107</sup> Feed dog Griffe Transportador inferior
-6/01	BN	1,2-40,0	91-176343-93 <sup>10</sup> = 1,2-2,8 mm <sup>41</sup> = 3,2 mm	91-047 563-04 <sup>10</sup> = 1,2-2,2 mm <sup>41</sup> = 3,2 mm
			91-176068-93 <sup>10</sup> = 3,2-4,0 mm	
			91-172 590-93 <sup>10</sup> = 4,8-7,2 mm	
			91-172 840-93 <sup>10</sup> = 8,0-14,0 mm	
			91-710 004-93 <sup>10</sup> = 15,2-34,0 mm	
91-710 234-93 <sup>10</sup> = 36,0-40,0 mm	91-047 565-04 <sup>10</sup> = 4,8-40,0 mm			
-6/01-900/56;/61	BN	1,2-24,0	91-176343-93 <sup>10</sup> = 1,2-2,8 mm <sup>41</sup> = 3,2 mm	91-059 312-04 <sup>10</sup> = 1,2-2,8 mm <sup>41</sup> = 3,2 mm
			91-176068-93 <sup>10</sup> = 3,2-4,4 mm	
			91-172 590-93 <sup>10</sup> = 4,8-7,2 mm	
			91-172 840-93 <sup>10</sup> = 8,0-14,0 mm	
			91-710 004-93 <sup>10</sup> = 15,2-24,0 mm	
91-059 313-04 <sup>10</sup> = 3,2-24,0 mm				
-6/01	CN	2,2-40,0	91-118 195-93 <sup>10</sup> = 2,2-2,8 mm <sup>41</sup> = 3,2 mm	91-047 563-04 <sup>10</sup> = 2,2-2,8 mm <sup>41</sup> = 3,2 mm
			91-710 004-93 <sup>10</sup> = 3,2-34,0 mm	
			91-710 234-93 <sup>10</sup> = 36,0-40,0 mm	
91-047 563-04 <sup>10</sup> = 3,2-4,0 mm				
91-047 565-04 <sup>10</sup> = 4,8-40,0 mm				
-6/01-900/56;/61	CN	2,2-24,0	91-118 195-93 <sup>10</sup> = 2,2-2,8 mm <sup>41</sup> = 3,2 mm	91-059 312-04 <sup>10</sup> = 2,2-2,8 mm <sup>41</sup> = 3,2 mm
			91-710 004-93 <sup>10</sup> = 3,2-24,0 mm	
			91-059 313-04 <sup>10</sup> = 3,2-4,4 mm	
91-059 313-04 <sup>10</sup> = 4,8-5,6 mm (C 2,0)				
91-059 313-04 <sup>10</sup> = 6,0-24,0 mm				
-6/03	BN	4,0-40,0	91-176068-93 <sup>10</sup> = 4,0 mm	91-047 563-04 <sup>10</sup> = 4,0 mm
			91-172 590-93 <sup>10</sup> = 4,8-7,2 mm	
			91-172 840-93 <sup>10</sup> = 8,0-14,0 mm	
			91-710 004-93 <sup>10</sup> = 15,2-34,0 mm	
			91-710 234-93 <sup>10</sup> = 36,0-40,0 mm	
91-047 565-04 <sup>10</sup> = 4,8-40,0 mm				
-6/03-900/56;/61	BN	4,0-24,0	91-176064-93 <sup>10</sup> = 4,0 mm	91-059 313-04 <sup>10</sup> = 4,0-24,0 mm
			91-172 590-93 <sup>10</sup> = 4,8-7,2 mm	
			91-172 840-93 <sup>10</sup> = 8,0-14,0 mm	
			91-710 004-93 <sup>10</sup> = 15,2-24,0 mm	
-6/03	CN	4,0-40,0	91-710 004-93 <sup>10</sup> = 4,0-40,0 mm	91-047 563-04 <sup>10</sup> = 4,0 mm
			91-047 565-04 <sup>10</sup> = 4,8-40,0 mm	
-6/03-900/56;/61	CN	4,0-24,0	91-710 004-93 <sup>10</sup> = 4,0-24,0 mm	91-059 313-04
-19/01	BN	4,8-12,0	91-172 590-93 <sup>10</sup> = 4,8-7,2 mm	91-047 565-04
			91-172 840-93 <sup>10</sup> = 8,0-12,0 mm	
-19/01-900/56;/61	BN	4,8-12,0	91-172 590-93 <sup>10</sup> = 4,8-7,2 mm	91-059 313-04
			91-172 840-93 <sup>10</sup> = 8,0-12,0 mm	
-19/01	CN	4,8-12,0	91-710 004-93 <sup>10</sup> = 4,8-12,0 mm	91-047 565-04
-19/01-900/56;/61	CN	4,8-12,0	91-710 004-93 <sup>10</sup> = 4,8-12,0 mm	91-059 313-04

**Equipement des sous-classes  
Unterklassen-Ausstattung**

**Dotación de las subclases  
Subclass organization**

Unterklasse Subclass Sous-classe Subclase	Ausführung Modell Variante Tipo de máquina	Suchplatte (1) (104) (107) Needle plate Plaque à aiguille Pieza de aguja	Mähtfuß (1) (107) Presser foot Pied presseur Pie prensateelas	Apparat (5) Attachment Appareil Aparato	Träger Bracket Support Soporte
-6/01	BN	91-158 514-04 $\overline{10}$ = 1,2 - 2,2 mm $\overline{41}$ = 3,2 mm 91-158 514-04 $\overline{10}$ = 2,4 - 4,0 mm 91-158 515-04 $\overline{10}$ = 4,8 - 40,0 mm	91-054 922-03 $\overline{10}$ = 1,2 - 4,0 mm $\overline{41}$ = 3,2 mm 91-054 926-03 $\overline{10}$ = 4,8 - 14,0 mm 91-054 927-03 $\overline{10}$ = 15,2 - 40,0 mm		
-6/01-900/56; /61	BN	91-158 815-04 $\overline{10}$ = 1,2 - 2,8 mm $\overline{41}$ = 3,2 mm 91-158 811-04 $\overline{10}$ = 3,2 - 24,0 mm	91-054 922-03 $\overline{10}$ = 1,2 - 4,0 mm $\overline{41}$ = 3,2 mm 91-054 926-03 $\overline{10}$ = 4,4 - 14,0 mm 91-054 927-03 $\overline{10}$ = 15,2 - 24,0 mm		
-6/01	CN	91-158 514-04 $\overline{10}$ = 2,2 - 2,8 mm $\overline{41}$ = 3,2 mm 91-158 514-04 $\overline{10}$ = 3,2 - 4,0 mm 91-158 515-04 $\overline{10}$ = 4,8 - 40,0 mm	91-054 922-03 $\overline{10}$ = 2,2 - 4,0 mm $\overline{41}$ = 3,2 mm 91-054 926-03 $\overline{10}$ = 4,8 - 14,0 mm 91-054 927-03 $\overline{10}$ = 15,2 - 40,0 mm		
-6/01-900/56; /61	CN	91-158 815-04 $\overline{10}$ = 2,2 - 2,8 mm $\overline{41}$ = 3,2 mm 91-158 811-04 $\overline{10}$ = 3,2 - 24,0 mm	91-054 922-03 $\overline{10}$ = 2,2 - 4,0 mm $\overline{41}$ = 3,2 mm 91-054 926-03 $\overline{10}$ = 4,4 - 14,0 mm 91-054 927-03 $\overline{10}$ = 15,2 - 24,0 mm		
-6/03	BN	91-158 514-04 $\overline{10}$ = 4,0 mm 91-158 515-04 $\overline{10}$ = 4,8 - 40,0 mm	91-055 499-93 $\overline{10}$ = 4,0 - 11,2 mm 91-055 506-93 $\overline{10}$ = 12,0 - 22,0 mm 91-055 507-93 $\overline{10}$ = 24,0 - 40,0 mm		
-6/03-900/56; /61	BN	91-158 811-04 $\overline{10}$ = 4,0 - 24,0 mm	91-055 499-93 $\overline{10}$ = 4,0 - 11,2 mm 91-055 506-93 $\overline{10}$ = 12,0 - 22,0 mm 91-055 507-93 $\overline{10}$ = 24,0 mm		
-6/03	CN	91-158 514-04 $\overline{10}$ = 4,0 mm 91-158 515-04 $\overline{10}$ = 4,8 - 40,0 mm	91-055 499-93 $\overline{10}$ = 4,0 - 11,2 mm 91-055 506-93 $\overline{10}$ = 12,0 - 22,0 mm 91-055 507-93 $\overline{10}$ = 24,0 - 40,0 mm		
-6/03-900/56; /61	CN	91-158 811-04	91-055 499-93 $\overline{10}$ = 4,0 - 11,2 mm 91-055 506-93 $\overline{10}$ = 12,0 - 22,0 mm 91-055 507-93 $\overline{10}$ = 24,0 mm		
-19/01	BN	91-158 515-04	91-055 609-03	91-041 006-23	91-753 936-90
-19/01-900/56; /61	BN	91-158 811-04	91-055 609-03	91-041 006-23	91-753 936-90
-19/01	CN	91-158 515-04	91-055 609-03	91-041 006-23	91-753 936-90
-19/01-900/56; /61	CN	91-158 811-04	91-055 609-03	91-041 006-23	91-753 936-90

## Equipement des sous-classes

## Dotación de las subclases

Unterklasse Subclass Sous-classe Subclase	Ausführung Model Version Tipo de maquina	Nadelabstand in mm Needle gauge in mm Ecartement des aiguilles en mm Distancia entre agujas en mm	Nadelhalter <sup>[107]</sup> Needle holder Pince-aiguille Portaagujas	Stoffschieber <sup>[107]</sup> Feed dog Griffe Transportador interior
-57/01	BN	4,8 - 10,0	91-172 590-93 $\frac{10}{10}$ = 4,8 - 7,2 mm 91-172 840-93 $\frac{10}{10}$ = 8,0 - 10,0 mm	91-047 565-04
-57/01-900/56;/61	BN	4,8 - 10,0	91-172 590-93 $\frac{10}{10}$ = 4,8 - 7,2 mm 91-172 840-93 $\frac{10}{10}$ = 8,0 - 10,0 mm	91-059 313-04
-57/01	CN	4,8 - 10,0	91-710 004-93	91-047 565-04
-57/01-900/56;/61	CN	4,8 - 10,0	91-710 004-93	91-059 313-04
-58/01	BN	4,8 - 10,0	91-172 590-93 $\frac{10}{10}$ = 4,8 - 7,2 mm 91-172 840-93 $\frac{10}{10}$ = 8,0 - 10,0 mm	91-047 565-04
58/01-900/56;/61	BN	4,8 - 10,0	91-172 590-93 $\frac{10}{10}$ = 4,8 - 7,2 mm 91-172 840-93 $\frac{10}{10}$ = 8,0 - 10,0 mm	91-059 313-04
-58/01	CN	4,8 - 10,0	91-710 004-93	91-047 565-04
-58/01-900/56;/61	CN	4,8 - 10,0	91-710 004-93	91-059 313-04
-61/01	BN	2,4 - 20,0	91-176 068-93 $\frac{10}{10}$ = 2,4 - 4,0 mm 91-172 590-93 $\frac{10}{10}$ = 4,8 - 7,2 mm 91-172 840-93 $\frac{10}{10}$ = 8,0 - 14,0 mm 91-710 004-93 $\frac{10}{10}$ = 15,2 - 20,0 mm	91-047 563-04 $\frac{10}{10}$ = 2,4 - 4,0 mm 91-047 565-04 $\frac{10}{10}$ = 4,8 - 20,0 mm
-61/01-900/56;/61	BN	2,4 - 20,0	91-176 068-93 $\frac{10}{10}$ = 2,4 - 4,0 mm 91-172 590-93 $\frac{10}{10}$ = 4,8 - 7,2 mm 91-172 840-93 $\frac{10}{10}$ = 8,0 - 14,0 mm 91-710 004-93 $\frac{10}{10}$ = 15,2 - 20,0 mm	91-059 313-04
-61/01	CN	3,2 - 20,0	91-710 004-93	91-047 563-04 $\frac{10}{10}$ = 3,2 - 4,0 mm 91-047 565-04 $\frac{10}{10}$ = 4,8 - 20,0 mm
-61/01-900/56;/61	CN	3,2 - 20,0	91-710 004-93	91-059 313-04
-113/02	BN	2,4 - 13,2	91-176 068-93 $\frac{10}{10}$ = 2,4 - 4,0 mm 91-172 590-93 $\frac{10}{10}$ = 4,8 - 7,2 mm 91-172 840-93 $\frac{10}{10}$ = 8,0 - 13,2 mm	91-047 563-04 $\frac{10}{10}$ = 2,4 - 4,0 mm 91-047 565-04 $\frac{10}{10}$ = 4,8 - 13,2 mm

Equipement des sous-classes  
Unterklassen-Ausstattung

Dotación de las subclases  
Subclass organization

Unterklass Subclass Subclase	Ausführung Model Version Tipo de máquina	Stichplatte Needle plate Plaque à aiguille Placa de agua	Nähfuß Presser foot Pied presseur Pie prensateelas	Apparat Attachment Appareil Aparato	Bandorientäger Tape reel bracket Supporteur Portarrollos
-57/01	BN	91-158 515-04	91-054 926-03	91-040 317-93	
-57/01-900/56;/61	BN	91-158 811-04	91-054 926-03	91-040 317-93	
-57/01	CN	91-158 515-04	91-054 926-03	91-040 317-93	
-57/01-900/56;/61	CN	91-158 811-04	91-054 926-03	91-040 317-93	
-58/01	BN	91-158 515-04	91-054 926-03	91-040 316-93	
58/01-900/56;/61	BN	91-158 811-04	91-054 926-03	91-040 316-93	
-58/01	CN	91-158 515-04	91-054 926-03	91-040 316-93	
-58/01-900/56;/61	CN	91-158 811-04	91-054 926-03	91-040 316-93	
-61/01	BN	91-158 514-04 $\overline{10}$ = 2,4 - 4,0 mm 91-158 515-04 $\overline{10}$ = 4,8 - 20,0 mm	91-157 658-03 $\overline{10}$ = 2,4 - 14,0 mm 91-157 730-03 $\overline{10}$ = 15,2 - 20,0 mm		91-040 2
-61/01-900/56;/61	BN	91-158 811-04	91-157 658-03 $\overline{10}$ = 2,4 - 14,0 mm 91-157 658-03 $\overline{10}$ = 15,2 - 20,0 mm		91-040 2
61/01	CN	91-158 514-04 $\overline{10}$ = 3,2 - 4,0 mm 91-158 515-04 $\overline{10}$ = 4,8 - 20,0 mm	91-157 658-03 $\overline{10}$ = 3,2 - 14,0 mm 91-157 730-03 $\overline{10}$ = 15,2 - 20,0 mm		91-040 2
61/01-900/56;/61	CN	91-158 811-11-04	91-157 658-03 $\overline{10}$ = 3,2 - 14,0 mm 91-157 730-03 $\overline{10}$ = 15,2 - 20,0 mm		91-040 2
113/02	BN	91-158 514-04 $\overline{10}$ = 2,4 - 4,0 mm 91-158 515-04 $\overline{10}$ = 4,8 - 13,2 mm	91-155 640-03 $\overline{10}$ = 2,4; 2,8 mm $\overline{12}$ = 1,0; 1,5; 2,0 mm 91-155 640-03 $\overline{10}$ = 3,2; 3,6 mm $\overline{12}$ = 1,0 mm 91-057 323-03 $\overline{10}$ = 3,2; 3,6 mm $\overline{12}$ = 1,5 mm 91-057 890-03 $\overline{10}$ = 4,0; 13,2 mm $\overline{12}$ = 1,0; 1,5 mm 91-057 318-03 $\overline{10}$ = 3,2; 3,6 mm $\overline{12}$ = 2,0; 2,5; 3,0; 3,5 mm 91-057 892-03 $\overline{10}$ = 4,0 - 13,2 mm $\overline{12}$ = 2,0; 2,5; 3,0; 3,5 mm	$\overline{60}$ $\overline{12/2}$	

Unterklassen-Ausstattung

Subclass Organization

Unterklasse Subclass Sous-classe Subclase	Ausführung Model Version Tipo de máquina	Nadelabstand in mm Needle gauge in mm Écartement des aiguilles en mm Distancia entre agujas en mm	Nadelhalter (10/2) Needle holder Pince-aiguille Puntaaguja	Stoffschieber (4) (10/1) (10/2) Feed dog Griffe Transportador inferior
-113/02-900/56;/61	BN	2,4 - 13,2	91-176 068-93 $\frac{10}{10}$ = 2,4 - 4,0 mm 91-172 590-93 $\frac{10}{10}$ = 4,8 - 7,2 mm 91-172 840-93 $\frac{10}{10}$ = 8,0 - 13,2 mm	91-059 313-04
-113/02	CN	3,2 - 13,2	91-710 004-93	91-047 563-04 $\frac{10}{10}$ = 3,2 - 4,0 mm 91-047 565-04 $\frac{10}{10}$ = 4,8 - 13,2 mm
-113/02-900/56;/61	CN	3,2 - 13,2	91-710 004-93	91-059 313-04

4 = Ausführung angeben  
= indicate model  
= Préciser la version  
= Indiquez el tipo de máquina

10/2 = Nadelabstand bei Bestellung angeben  
= State needle gauge on order  
= Indiquer écartement des aiguilles à la commande  
= Indiquez en los pedidos la distancia entre agujas

41 = Nadel diagonalabstand  
= Diagonal needle distance  
= Espacement diagonal des aiguilles  
= Distancia diagonal entre agujas

10 = Nadelabstand  
= Needle gauge  
= Écartement des aiguilles  
= Distancias entre agujas

12 = Absteppbreite  
= Stitching margin  
= Relarge de couture  
= Margen de costura

60 = Wahlweise  
= Optional  
= Au choix  
= Opcional

10/1 = je nach Nadelabstand ändert sich die Form  
(z.B. beim Stoffschieber die Anzahl  
der Zahnreihen)  
= Certain design features change according  
to the needle gauge (e.g. the number of tooth  
rows on the feed dog)  
= La forme est fonction de l'écartement  
des aiguilles (par ex. le nombre des rangées  
de dents de la griffe)  
= La forma varia de acuerdo con la distancia entre agujas

12/2 = Absteppbreite bei Bestellung angeben  
= Indicate stitching margin on order  
= Indiquer le relarge de couture à la commande  
= Indiquez el margen de costura en los pedidos

Equipement des sous-classes

Dotación de las subclases

Unterklassen-Ausstattung

Subclass organization

Sous-classe Subclass	Ausführung Model Version Tipo de máquina	Stichplatte Handle plate Placa a signalle Placa de aguja	Altimeter Altimètre Piezometre Pie presostatis
3/02-900/56;/61	BN	91-158 811-04	91-155 640-03 $\overline{10}$ = 2,4; 2,8 mm $\overline{12}$ = 1,0; 1,5; 2,0 mm 91-155 640-03 $\overline{10}$ = 3,2; 3,6 mm $\overline{12}$ = 1,0 mm 91-057 323-03 $\overline{10}$ = 3,2; 3,6 mm $\overline{12}$ = 1,5 mm 91-057 890-03 $\overline{10}$ = 4,0 - 13,2 mm $\overline{12}$ = 1,0; 1,5 mm 91-057 318-03 $\overline{10}$ = 3,2; 3,6 mm $\overline{12}$ = 2,0; 2,5; 3,0; 3,5 mm 91-057 892-03 $\overline{10}$ = 4,0 - 13,2 mm $\overline{12}$ = 2,0; 2,5; 3,0; 3,5 mm
3/02	CN	91-158 514-04 $\overline{10}$ = 3,2 - 4,0 mm 91-158 515-04 $\overline{10}$ = 4,8 - 13,2 mm	91-155 640-03 $\overline{10}$ = 3,2; 3,6 mm $\overline{12}$ = 1,0 mm 91-057 323-03 $\overline{10}$ = 3,2; 3,6 mm $\overline{12}$ = 1,5 mm 91-057 318-03 $\overline{10}$ = 3,2; 3,6 mm $\overline{12}$ = 2,0; 2,5; 3,0; 3,5 mm 91-057 890-03 $\overline{10}$ = 4,0 - 13,2 mm $\overline{12}$ = 1,0; 1,5 mm 91-057 892-03 $\overline{10}$ = 4,0 - 13,2 mm $\overline{12}$ = 2,0; 2,5; 3,0; 3,5 mm
3/02-900/56;/61	CN	91-158 811-04	91-155 640-03 $\overline{10}$ = 3,2; 3,6 mm $\overline{12}$ = 1,0 mm 91-057 323-03 $\overline{10}$ = 3,2; 3,6 mm $\overline{12}$ = 1,5 mm 91-057 318-03 $\overline{10}$ = 3,2; 3,6 mm $\overline{12}$ = 2,0; 2,5; 3,0; 3,5 mm 91-057 890-03 $\overline{10}$ = 4,0 - 13,2 mm $\overline{12}$ = 1,0; 1,5 mm 91-057 892-03 $\overline{10}$ = 4,0 - 13,2 mm $\overline{12}$ = 2,0; 2,5; 3,0; 3,5 mm

Unterklassen-Übersicht/Table of subclasses/Table des sous-classes/Tabla de subclases

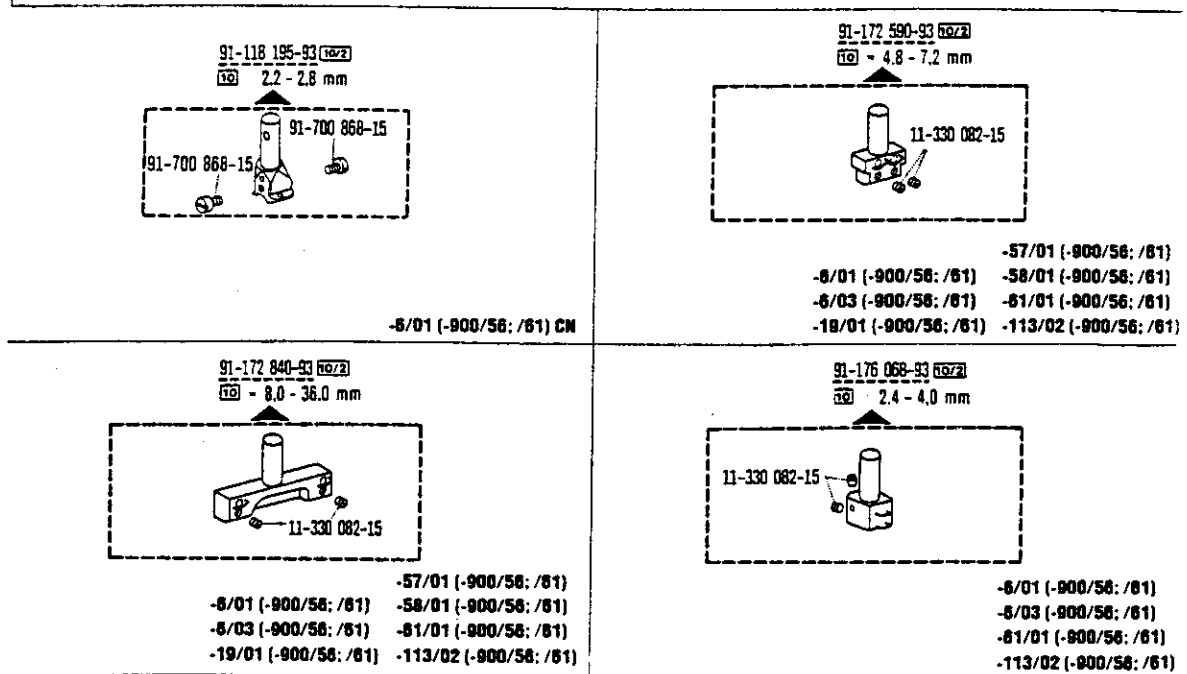



UNTERKASSEN-ÜBUNG

91-176 343-93 <sup>10/2</sup>  
<sup>10</sup> = 1,2 - 2,8 mm

11-330 082-15

11-330 082-15

-6/01 (-900/56; /61)

91-710 004-93 <sup>10/2</sup>  
<sup>10</sup> = 4,0 - 40,0 mm

91-173 664-15

91-173 664-15

-57/01 (-900/56; /61)  
 -6/01 (-900/56; /61) -58/01 (-900/56; /61)  
 -6/03 (-900/56; /61) -61/01 (-900/56; /61)  
 -19/01 (-900/56; /61) -113/02 (-900/56; /61)

91-710 234-93 <sup>10/2</sup>  
<sup>10</sup> = 36,0 - 40,0 mm

91-173 664-15

91-173 664-15

-6/01  
 -6/03

91-047 563-04 <sup>4</sup> <sup>10/2</sup>  
<sup>10</sup> = 1,2 - 2,0 mm    <sup>10</sup> = 2,4 - 4,0 mm  
<sup>41</sup> = 3,2 mm

91-047 563-04

91-047 563-04

-6/01  
 -6/03  
 -61/01  
 -113/02

91-047 565-04 <sup>4</sup> <sup>10/1</sup> <sup>10/2</sup>  
<sup>10</sup> = 4,8 - 40,0 mm

91-047 565-04

-6/01  
 -6/03  
 -19/01  
 -57/01  
 -58/01  
 -61/01  
 -113/02

91-059 312-04 <sup>4</sup> <sup>10/2</sup>  
<sup>10</sup> = 1,2 - 2,8 mm  
<sup>41</sup> = 3,2 mm

91-059 312-04

-6/01-900/56; /61

91-059 313-04 <sup>4</sup> <sup>10/1</sup> <sup>10/2</sup>  
<sup>10</sup> = 3,2 - 4,4 mm    <sup>10</sup> = 4,8 - 24,0 mm

91-059 313-04

91-059 313-04

-6/01 (-900/56; /61)  
 -6/03 (-900/56; /61)  
 -19/01 (-900/56; /61)  
 -57/01 (-900/56; /61)  
 -58/01 (-900/56; /61)  
 -61/01 (-900/56; /61)  
 -113/02 (-900/56; /61)

91-158 514-04 <sup>4</sup> <sup>10/2</sup>  
<sup>10</sup> = 1,2 - 4,0 mm

91-158 514-04

-6/01  
 -6/03  
 -61/01  
 -113/02

91-158 515-04 <sup>4</sup> <sup>10/1</sup> <sup>10/2</sup>  
<sup>10</sup> = 4,8 - 40,0 mm

91-158 515-04

-6/01  
 -6/03  
 -19/01  
 -57/01  
 -58/01  
 -61/01  
 -113/02

91-158 811-04 <sup>4</sup> <sup>10/1</sup> <sup>10/2</sup>  
<sup>10</sup> = 2,4 - 8,0 mm

91-158 811-04

-6/01-900/56; /61  
 -6/03-900/56; /61  
 -19/01-900/56; /61  
 -57/01-900/56; /61  
 -58/01-900/56; /61  
 -61/01-900/56; /61  
 -113/02-900/56; /61

91-158 815-04 <sup>4</sup> <sup>10/2</sup>  
<sup>10</sup> = 1,2 - 2,8 mm

91-158 815-04

-6/01-900/56; /61

91-054 922-03 <sup>4</sup> <sup>10/2</sup>

91-054 922-03

-6/01 (-900/56; /61)

91-054 926-03 <sup>4</sup> <sup>10/2</sup>

91-054 926-03

-6/01 (-900/56; /61)  
 -57/01 (-900/56; /61)  
 -58/01 (-900/56; /61)

91-054 927-03 <sup>4</sup> <sup>10/2</sup>

91-054 927-03





-6/01 (-900/56; /61)

91-055 499-93 <sup>4</sup> <sup>10/2</sup>

91-055 499-93

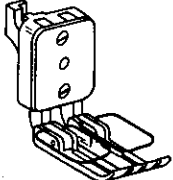
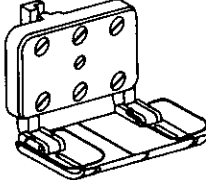
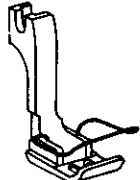
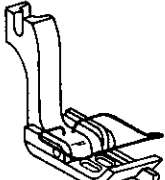
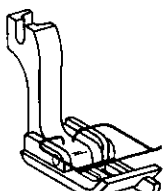
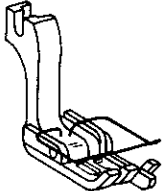
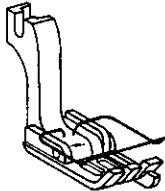
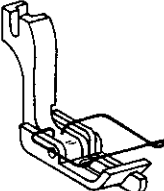
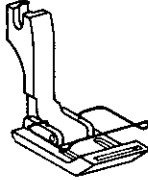
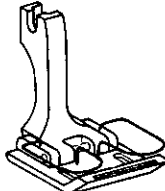
-6/03 (-900/56; /61)

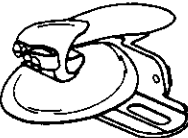
**Unterklassen-Ubersicht/ Table of subclasses/ Table des sous-classes/ Tabla de subclasses**

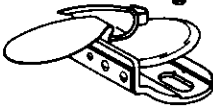
<p>91-055 506-93 <span style="border: 1px solid black; padding: 0 2px;">4</span> <span style="border: 1px solid black; padding: 0 2px;">10/2</span></p>  <p>-6/03 (-900/56; /61)</p>	<p>91-055 507-93 <span style="border: 1px solid black; padding: 0 2px;">4</span> <span style="border: 1px solid black; padding: 0 2px;">10/2</span></p>  <p>-6/03 (-900/56; /61)</p>	<p>91-055 609-03 <span style="border: 1px solid black; padding: 0 2px;">4</span> <span style="border: 1px solid black; padding: 0 2px;">10/2</span></p>  <p>-19/01 (-900/56; /61)</p>	<p>91-057 318-03 <span style="border: 1px solid black; padding: 0 2px;">4</span> <span style="border: 1px solid black; padding: 0 2px;">10/2</span> <span style="border: 1px solid black; padding: 0 2px;">12/2</span></p>  <p>-113/02 (-900/56; /61)</p>
<p>91-057 323-03 <span style="border: 1px solid black; padding: 0 2px;">4</span> <span style="border: 1px solid black; padding: 0 2px;">10/2</span> <span style="border: 1px solid black; padding: 0 2px;">12/2</span></p>  <p>-113/02 (-900/56; /61)</p>	<p>91-057 890-03 <span style="border: 1px solid black; padding: 0 2px;">4</span> <span style="border: 1px solid black; padding: 0 2px;">10/2</span> <span style="border: 1px solid black; padding: 0 2px;">12/2</span></p>  <p>-113/02 (-900/56; /61)</p>	<p>91-057 892-03 <span style="border: 1px solid black; padding: 0 2px;">4</span> <span style="border: 1px solid black; padding: 0 2px;">10/2</span> <span style="border: 1px solid black; padding: 0 2px;">12/2</span></p>  <p>-113/02 (-900/56; /61)</p>	<p>91-155 640-03 <span style="border: 1px solid black; padding: 0 2px;">4</span> <span style="border: 1px solid black; padding: 0 2px;">10/2</span> <span style="border: 1px solid black; padding: 0 2px;">12/2</span></p>  <p>-113/02 (-900/56; /61)</p>
<p>91-157 658-03 <span style="border: 1px solid black; padding: 0 2px;">4</span> <span style="border: 1px solid black; padding: 0 2px;">10/2</span></p>  <p>-61/01 (-900/56; /61)</p>		<p>91-157 730-03 <span style="border: 1px solid black; padding: 0 2px;">4</span> <span style="border: 1px solid black; padding: 0 2px;">10/2</span></p>  <p>-61/01 (-900/56; /61)</p>	
<p>91-040 316-93 <span style="border: 1px solid black; padding: 0 2px;">5</span> <span style="border: 1px solid black; padding: 0 2px;">10/2</span></p> <p>91-000 521-25 </p>  <p>-58/01 (-900/56; /61)</p>		<p>91-040 317-93 <span style="border: 1px solid black; padding: 0 2px;">5</span> <span style="border: 1px solid black; padding: 0 2px;">10/2</span></p> <p>91-000 521-25 </p>  <p>-57/01 (-900/56; /61)</p>	

91-041 006-23 5

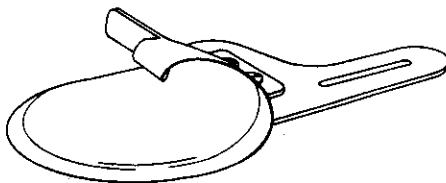

-10/01 (-900/56; /61)

Unterklassen-Übersicht/ Table of subclasses/ Table des sous-classes/ Tabla de subclasses

91-753 936-90

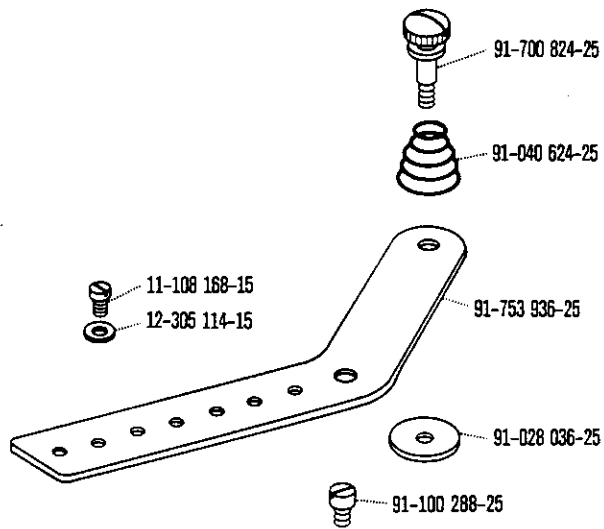

-19/01 (-900/56; /61)

91-040 207-91

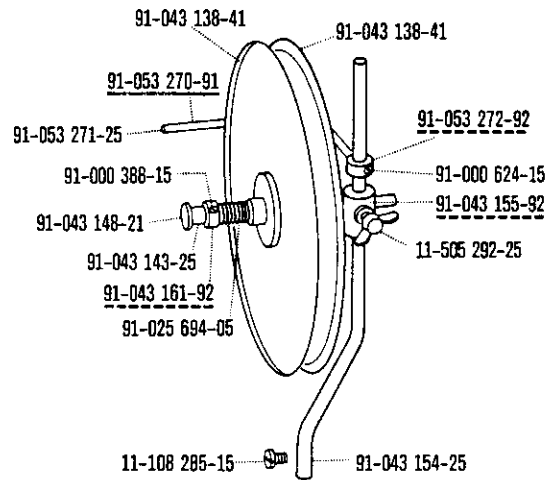

-61/01 (-900/56; /61)